

STEEL WALL POOL SYSTEM

14'-3" X 28'-3" GRECIAN

DWG #: GS-1022 DATE: 8/9/2011 REV: C PAGE 2 OF 2

TURNBUCKLE BRACE

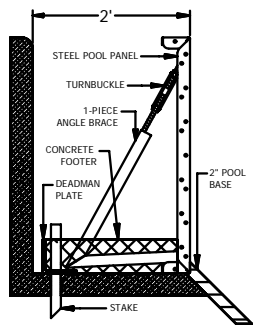

EMBEDDED NUT BRACE

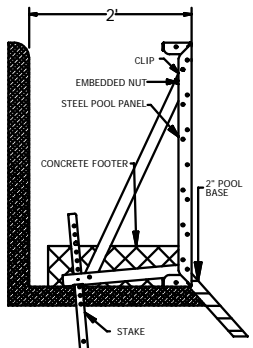

DECK SUPPORT (OPTIONAL)

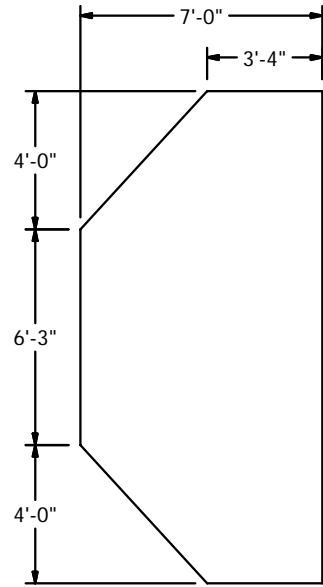
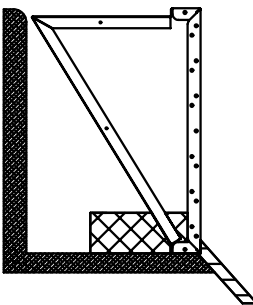

45 DEG DETAIL

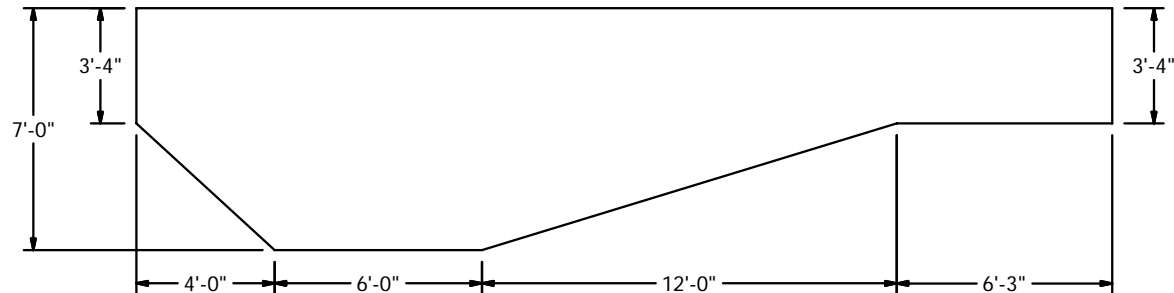
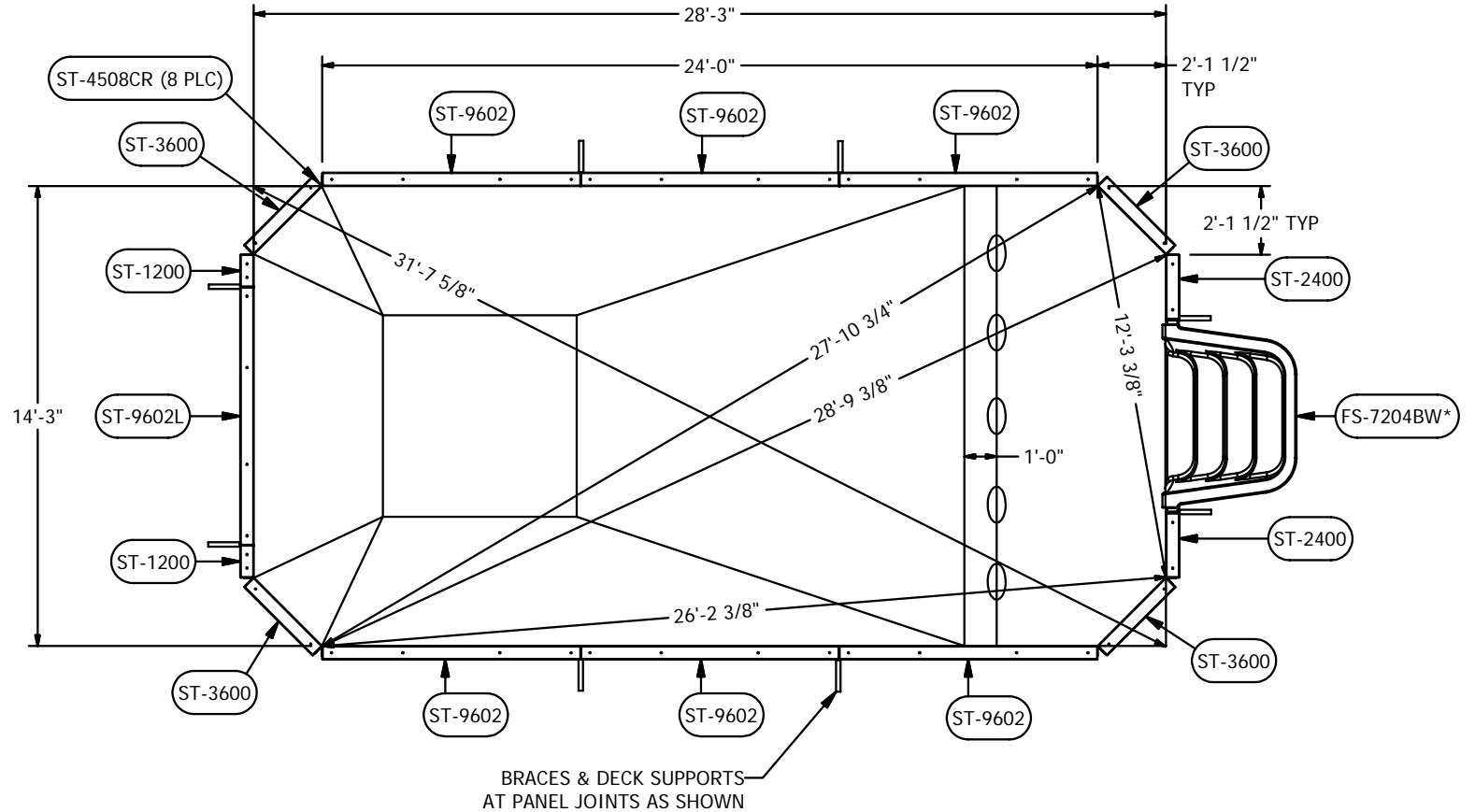
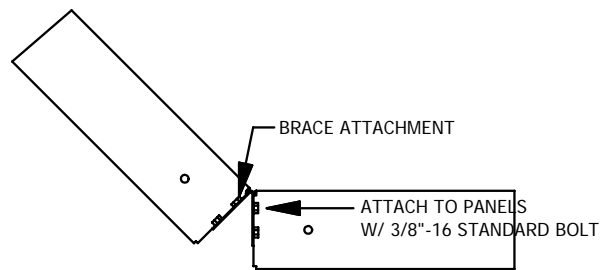

N.S.P.I. TYPE 0

NO DIVING DANGER: DIVING MAY RESULT IN SERIOUS INJURY OR DEATH. Signage must be permanently attached around the perimeter of the pool.

THIS DOCUMENT IS FOR ILLUSTRATIVE PURPOSES ONLY. Trivector Mfg. Inc. makes only those representations which are stated in its written warranty. Any other representations, statements, or contracts made by the dealer/contractor to the customer regarding any components produced by Trivector Mfg. Inc. are attributable to the dealer/contractor only. The dealer or contractor who sells or installs your pool is an independent contractor and is not an agent or employee of Trivector Mfg. Inc. The construction methods illustrated here are suggestions and apply only to normal ground conditions. There may be additional precautions and/or methods of construction. The responsibility is the contractor's. -A safety line, with buoys, is to be permanently attached 1'-0" to the shallow side of the point of first slope change. -Different methods and precautions may be dictated by various ground conditions. This is to be determined by and is the responsibility of the contractor who is not an agent of the manufacturer of the component parts. -Installation is to be done in accordance with all federal, state and local building codes, as well as A.N.S.I./N.S.P.I. suggested standards. -BOTTOM SPECIFICATIONS MUST MEET OR EXCEED A.N.S.I./N.S.P.I./A.P.S.P. RECOMMENDED STANDARDS -"NO DIVING" signage must be permanently attached to the entire perimeter of the pool. See instructions with signage. *IT IS RECOMMENDED TO NOT INSTALL DIVING BOARDS AND/OR SLIDING EQUIPMENT ON RESIDENTIAL POOLS*. Then add the following: If diving boards and/or sliding equipment is installed by the contractor, such diving boards and sliding equipment MUST BE INSTALLED WITHIN THE GUIDELINES ESTABLISHED BY ANSI/NSPI/ASPA RECOMMENDED STANDARDS, AND IN ACCORDANCE WITH ALL APPLICABLE STATE AND LOCAL CODES AND REGULATIONS.



STEEL WALL POOL SYSTEM

16'-6" X 32'-6" GRECIAN

DWG #: GS-1023 DATE: 8/9/2011 REV: C PAGE 2 OF 2

TURNBUCKLE BRACE

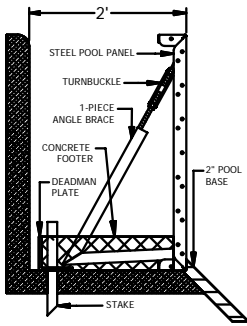

EMBEDDED NUT BRACE

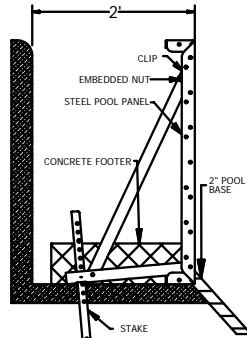

DECK SUPPORT (OPTIONAL)

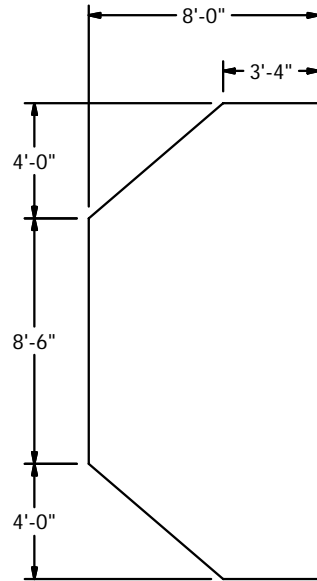
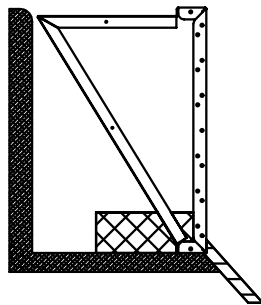

45 DEG DETAIL

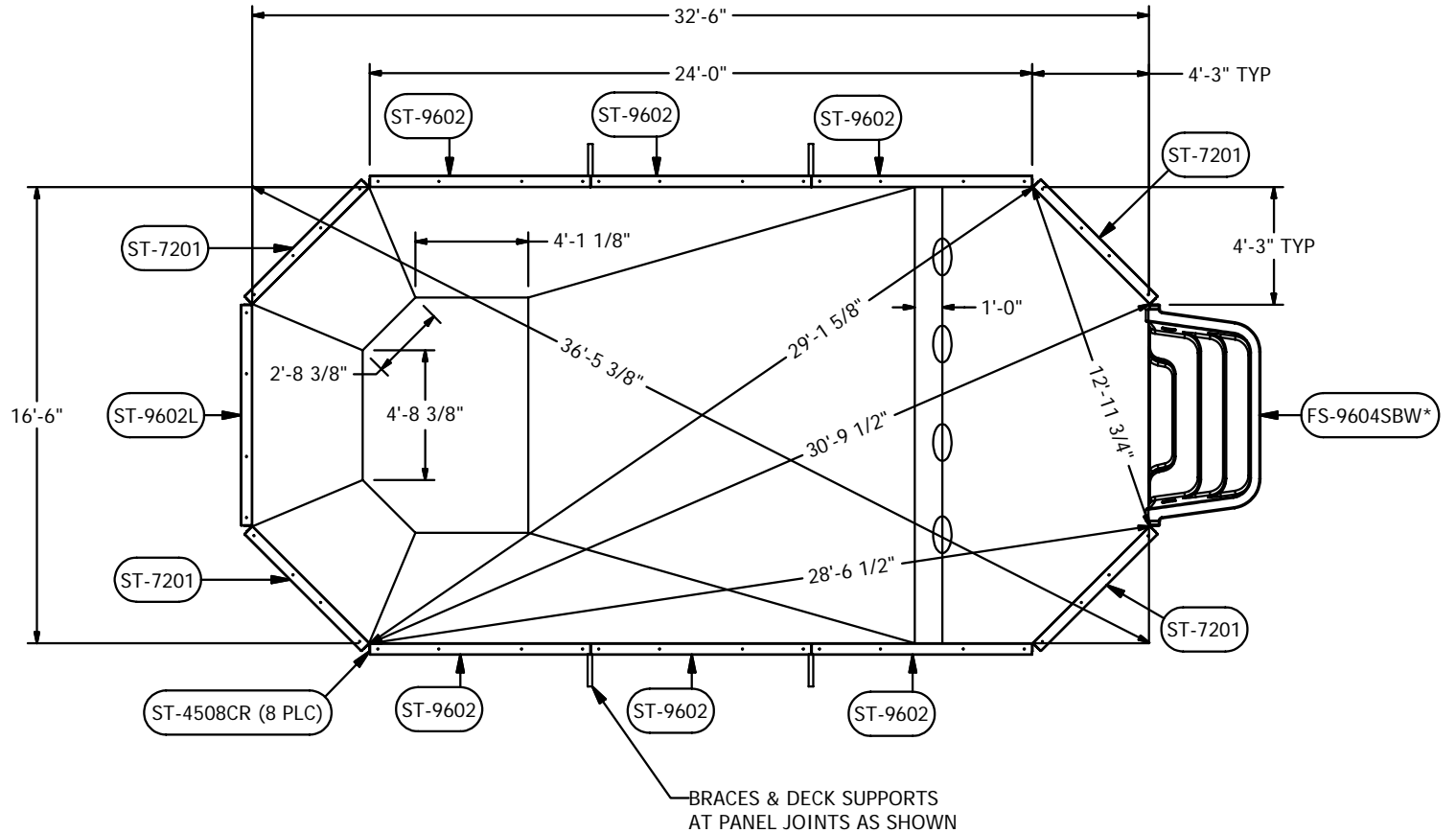
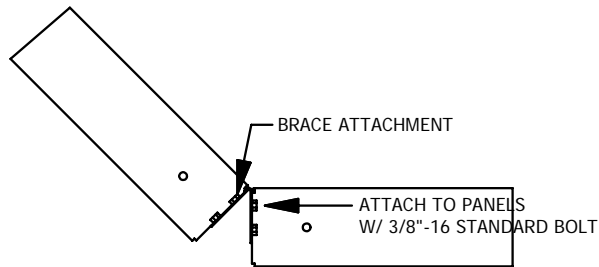

N.S.P.I. TYPE 2

NO DIVING DANGER: DIVING MAY RESULT IN SERIOUS INJURY OR DEATH. Signage must be permanently attached around the perimeter of the pool.

THIS DOCUMENT IS FOR ILLUSTRATIVE PURPOSES ONLY. Trivector Mfg. Inc. makes only those representations which are stated in its written warranty. Any other representations, statements, or contracts made by the dealer/contractor to the customer regarding any components produced by Trivector Mfg. Inc. are attributable to the dealer/contractor only. The dealer or contractor who sells or installs your pool is an independent contractor and is not an agent or employee of Trivector Mfg. Inc. The construction methods illustrated here are suggestions and apply only to normal ground conditions. There may be additional precautions and/or methods of construction. The responsibility is the contractor's. -A safety line, with buoys, is to be permanently attached 1'-0" to the shallow side of the point of first slope change. -Different methods and precautions may be dictated by various ground conditions. This is to be determined by and is the responsibility of the contractor who is not an agent of the manufacturer of the component parts. -Installation is to be done in accordance with all federal, state and local building codes, as well as A.N.S.I./N.S.P.I. suggested standards. -BOTTOM SPECIFICATIONS MUST MEET OR EXCEED A.N.S.I./N.S.P.I./A.P.S.P. RECOMMENDED STANDARDS -"NO DIVING" signage must be permanently attached to the entire perimeter of the pool. See instructions with signage. **"IT IS RECOMMENDED TO NOT INSTALL DIVING BOARDS AND/OR SLIDING EQUIPMENT ON RESIDENTIAL POOLS"**. Then add the following: **If diving boards and/or sliding equipment is installed by the contractor, such diving boards and sliding equipment MUST BE INSTALLED WITHIN THE GUIDELINES ESTABLISHED BY ANSI/NSPI/ASPA RECOMMENDED STANDARDS, AND IN ACCORDANCE WITH ALL APPLICABLE STATE AND LOCAL CODES AND REGULATIONS.**



STEEL WALL POOL SYSTEM

18'-6" X 36'-6" GRECIAN

DWG #: GS-1024 DATE: 8/9/2011 REV: C PAGE 2 OF 2

TURNBUCKLE BRACE

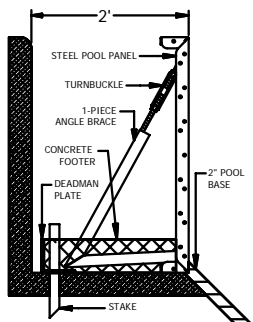

EMBEDDED NUT BRACE

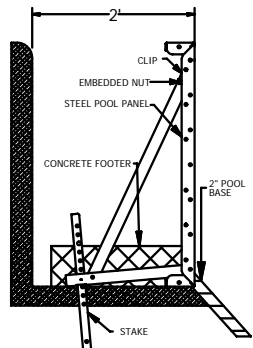

DECK SUPPORT (OPTIONAL)

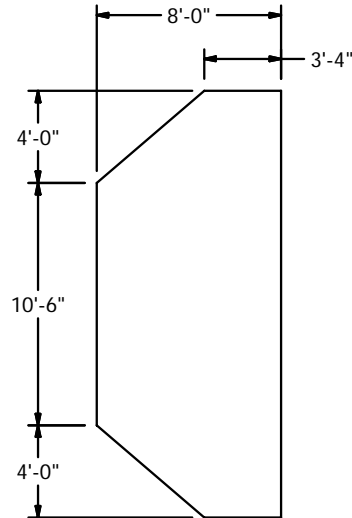
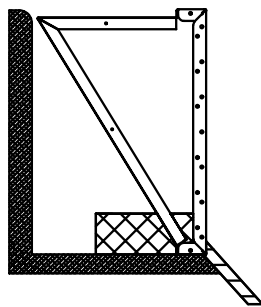

45 DEG DETAIL

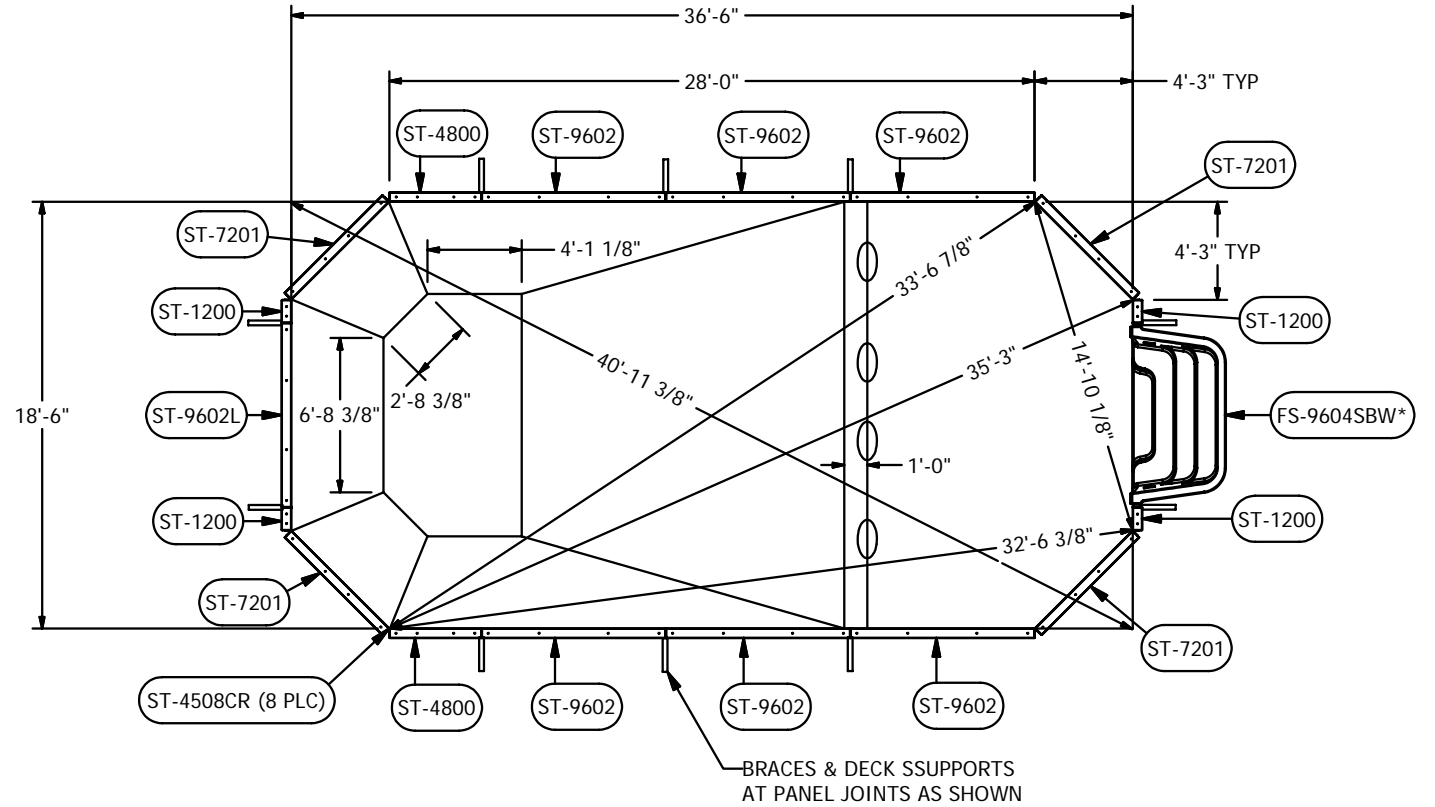
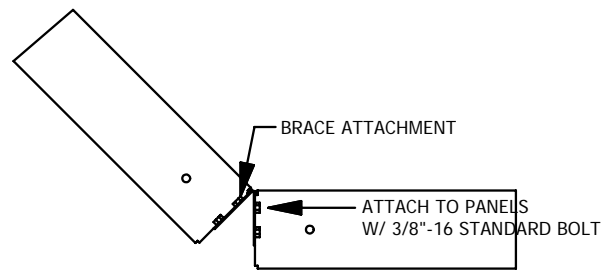

N.S.P.I. TYPE 2

NO DIVING DANGER: DIVING MAY RESULT IN SERIOUS INJURY OR DEATH. Signage must be permanently attached around the perimeter of the pool.

THIS DOCUMENT IS FOR ILLUSTRATIVE PURPOSES ONLY. Trivector Mfg. Inc. makes only those representations which are stated in its written warranty. Any other representations, statements, or contracts made by the dealer/contractor to the customer regarding any components produced by Trivector Mfg. Inc. are attributable to the dealer/contractor only. The dealer or contractor who sells or installs your pool is an independent contractor and is not an agent or employee of Trivector Mfg. Inc. The construction methods illustrated here are suggestions and apply only to normal ground conditions. There may be additional precautions and/or methods of construction. The responsibility is the contractor's. -A safety line, with buoys, is to be permanently attached 1'-0" to the shallow side of the point of first slope change. -Different methods and precautions may be dictated by various ground conditions. This is to be determined by and is the responsibility of the contractor who is not an agent of the manufacturer of the component parts. -Installation is to be done in accordance with all federal, state and local building codes, as well as A.N.S.I./N.S.P.I. suggested standards. -BOTTOM SPECIFICATIONS MUST MEET OR EXCEED A.N.S.I./N.S.P.I./A.P.S.P. RECOMMENDED STANDARDS -"NO DIVING" signage must be permanently attached to the entire perimeter of the pool. See instructions with signage. *IT IS RECOMMENDED TO NOT INSTALL DIVING BOARDS AND/OR SLIDING EQUIPMENT ON RESIDENTIAL POOLS*. Then add the following: If diving boards and/or sliding equipment is installed by the contractor, such diving boards and sliding equipment MUST BE INSTALLED WITHIN THE GUIDELINES ESTABLISHED BY ANSI/NSPI/ASPA RECOMMENDED STANDARDS, AND IN ACCORDANCE WITH ALL APPLICABLE STATE AND LOCAL CODES AND REGULATIONS.



STEEL WALL POOL SYSTEM

20'-9" X 39'-9" GRECIAN

DWG #: GS-1025 DATE: 8/9/2011 REV: C PAGE 2 OF 2

TURNBUCKLE BRACE

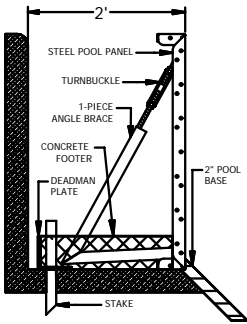

EMBEDDED NUT BRACE

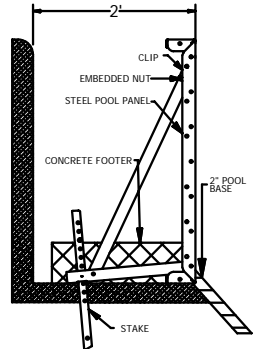

DECK SUPPORT (OPTIONAL)

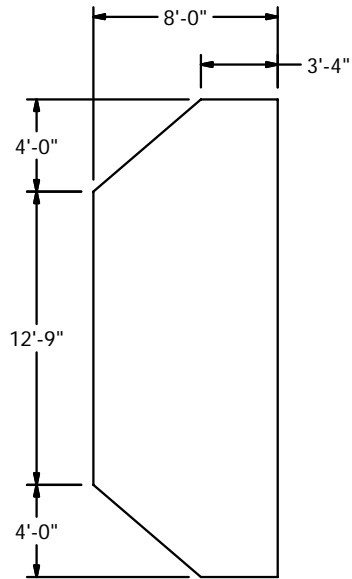
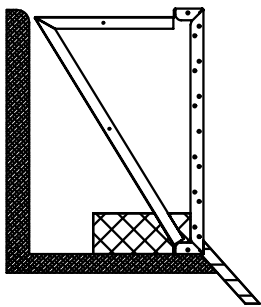

45 DEG DETAIL

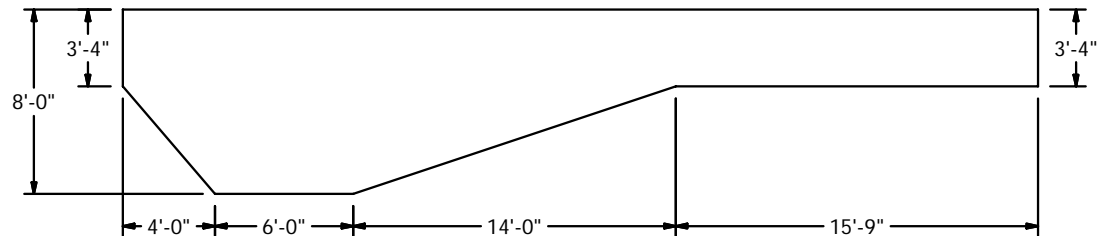
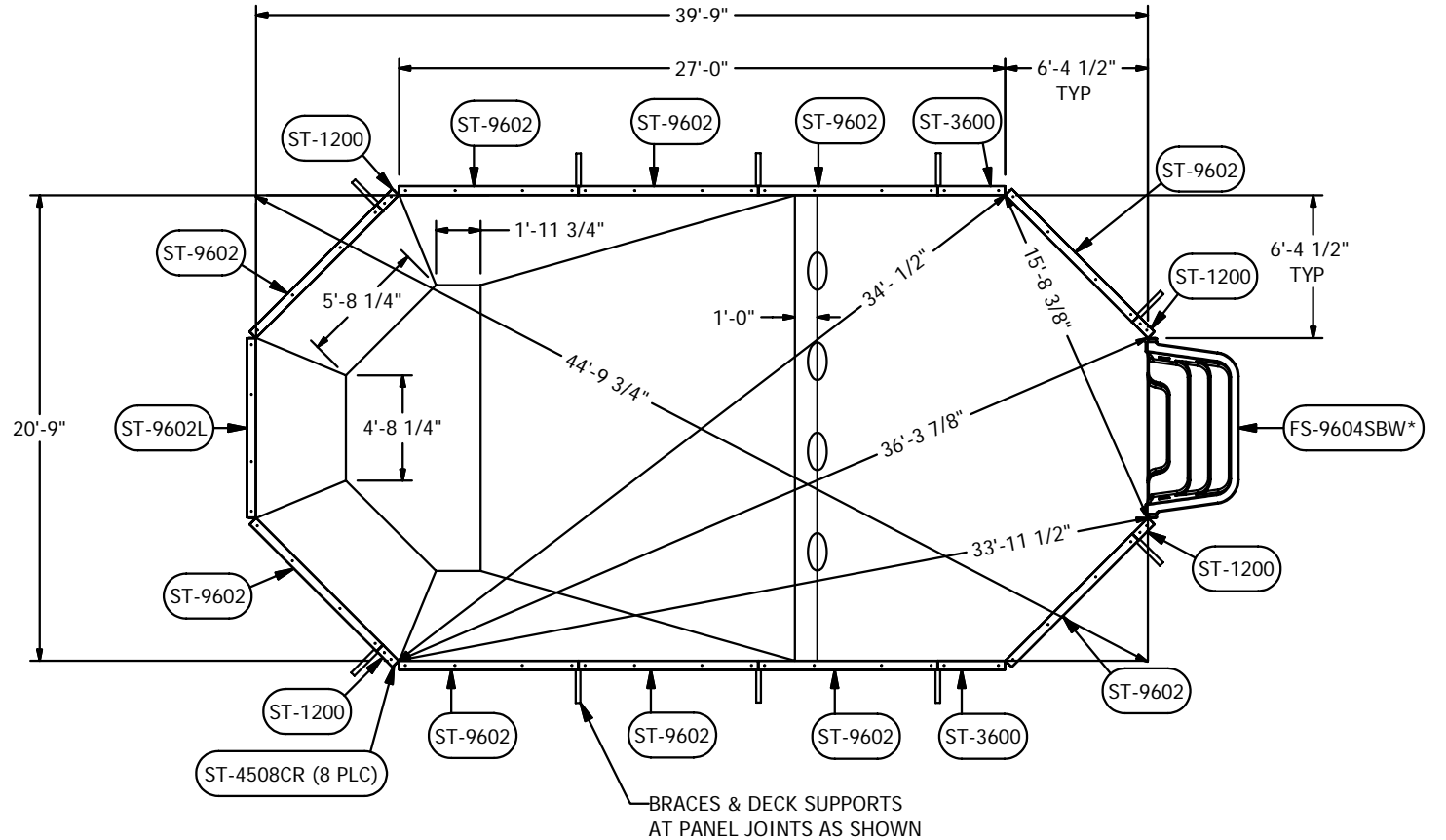
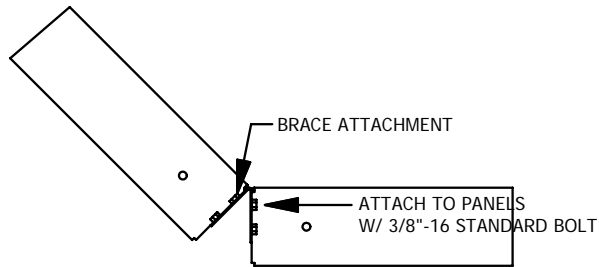

N.S.P.I. TYPE 2

NO DIVING DANGER: DIVING MAY RESULT IN SERIOUS INJURY OR DEATH. Signage must be permanently attached around the perimeter of the pool.

THIS DOCUMENT IS FOR ILLUSTRATIVE PURPOSES ONLY. Trivector Mfg. Inc. makes only those representations which are stated in its written warranty. Any other representations, statements, or contracts made by the dealer/contractor to the customer regarding any components produced by Trivector Mfg. Inc. are attributable to the dealer/contractor only. The dealer or contractor who sells or installs your pool is an independent contractor and is not an agent or employee of Trivector Mfg. Inc. The construction methods illustrated here are suggestions and apply only to normal ground conditions. There may be additional precautions and/or methods of construction. The responsibility is the contractor's. -A safety line, with buoys, is to be permanently attached 1'-0" to the shallow side of the point of first slope change. -Different methods and precautions may be dictated by various ground conditions. This is to be determined by and is the responsibility of the contractor who is not an agent of the manufacturer of the component parts. -Installation is to be done in accordance with all federal, state and local building codes, as well as A.N.S.I./N.S.P.I. suggested standards. -BOTTOM SPECIFICATIONS MUST MEET OR EXCEED A.N.S.I./N.S.P.I./A.P.S.P. RECOMMENDED STANDARDS -"NO DIVING" signage must be permanently attached to the entire perimeter of the pool. See instructions with signage. *IT IS RECOMMENDED TO NOT INSTALL DIVING BOARDS AND/OR SLIDING EQUIPMENT ON RESIDENTIAL POOLS*. Then add the following: If diving boards and/or sliding equipment is installed by the contractor, such diving boards and sliding equipment MUST BE INSTALLED WITHIN THE GUIDELINES ESTABLISHED BY ANSI/NSPI/ASPA RECOMMENDED STANDARDS, AND IN ACCORDANCE WITH ALL APPLICABLE STATE AND LOCAL CODES AND REGULATIONS.



STEEL WALL POOL SYSTEM

22'-9" X 43'-9" GRECIAN

DWG #: GS-1026 DATE: 8/9/2011 REV: C PAGE 2 OF 2

TURNBUCKLE BRACE

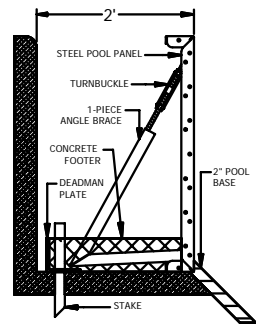

EMBEDDED NUT BRACE

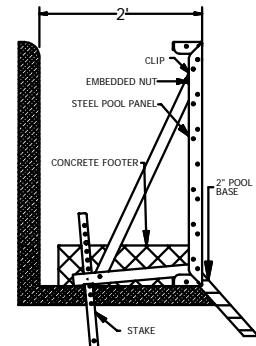

DECK SUPPORT (OPTIONAL)

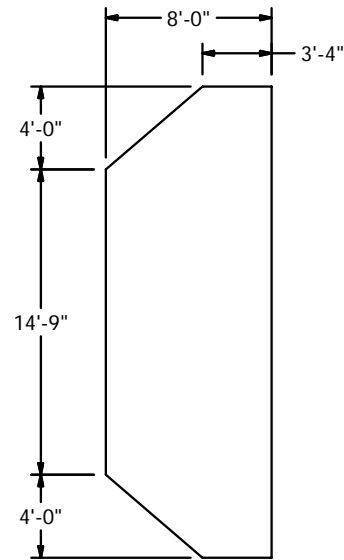
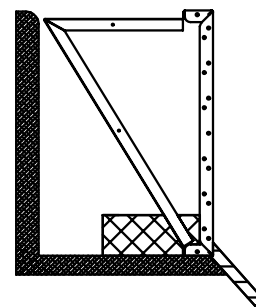

45 DEG DETAIL

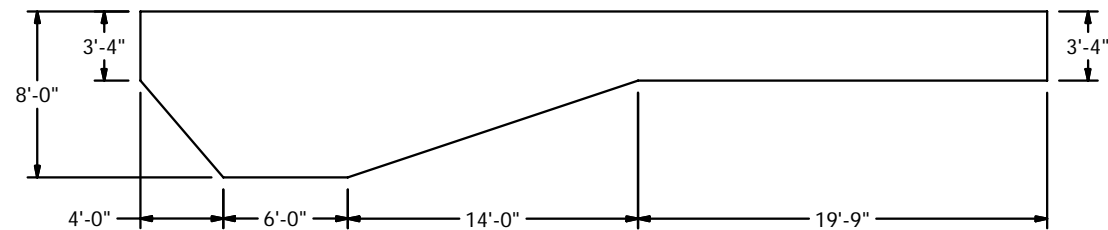
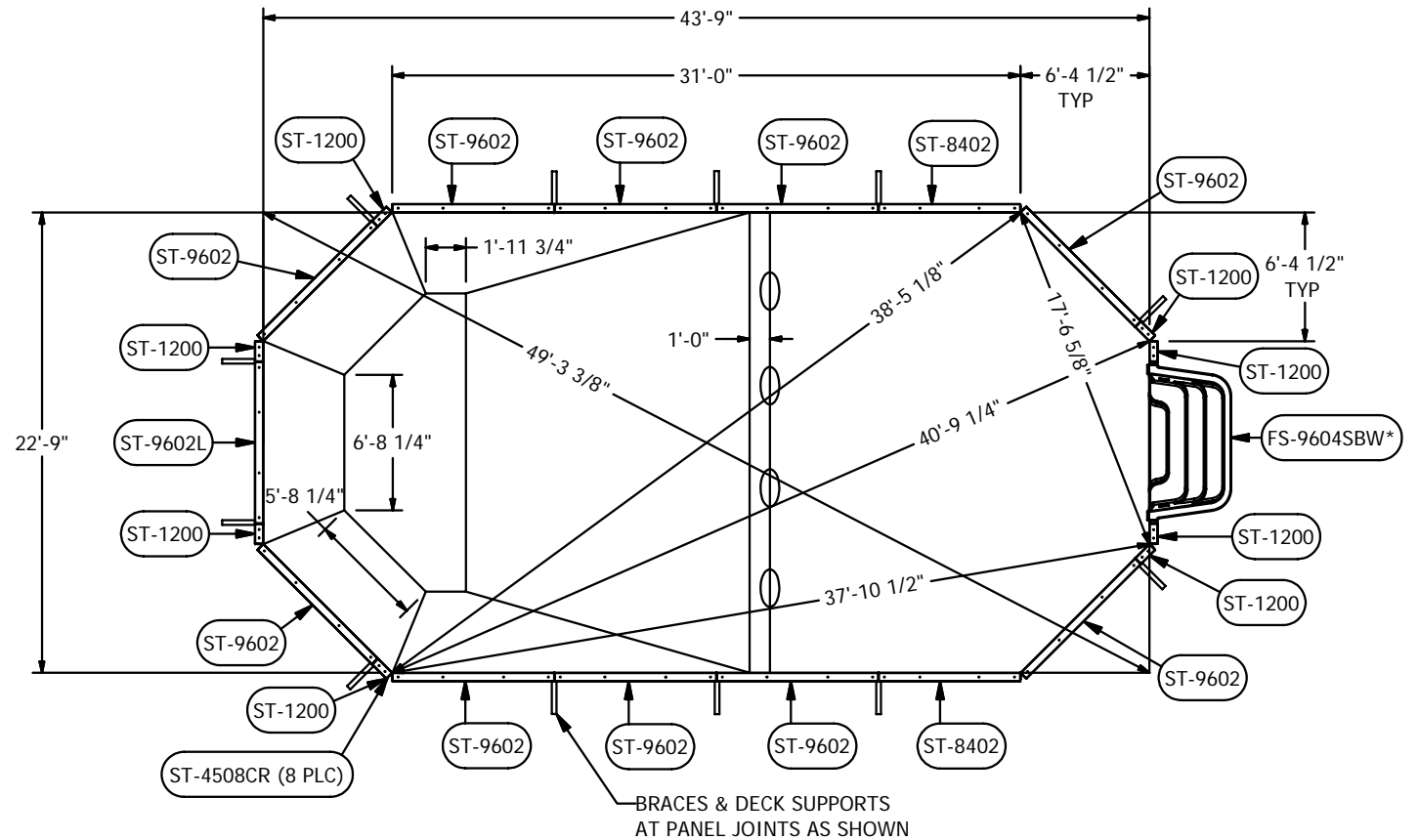
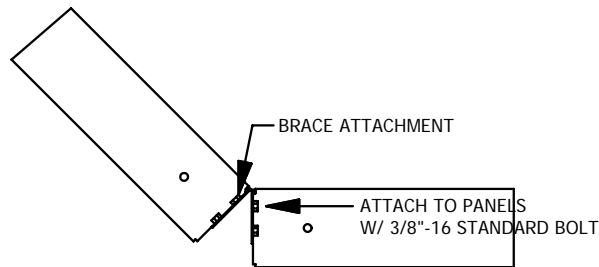

N.S.P.I. TYPE 2

NO DIVING DANGER: DIVING MAY RESULT IN SERIOUS INJURY OR DEATH. Signage must be permanently attached around the perimeter of the pool.

THIS DOCUMENT IS FOR ILLUSTRATIVE PURPOSES ONLY. Trivector Mfg. Inc. makes only those representations which are stated in its written warranty. Any other representations, statements, or contracts made by the dealer/contractor to the customer regarding any components produced by Trivector Mfg. Inc. are attributable to the dealer/contractor only. The dealer or contractor who sells or installs your pool is an independent contractor and is not an agent or employee of Trivector Mfg. Inc. The construction methods illustrated here are suggestions and apply only to normal ground conditions. There may be additional precautions and/or methods of construction. The responsibility is the contractor's. -A safety line, with buoys, is to be permanently attached 1'-0" to the shallow side of the point of first slope change. -Different methods and precautions may be dictated by various ground conditions. This is to be determined by and is the responsibility of the contractor who is not an agent of the manufacturer of the component parts. -Installation is to be done in accordance with all federal, state and local building codes, as well as A.N.S.I./N.S.P.I. suggested standards. -BOTTOM SPECIFICATIONS MUST MEET OR EXCEED A.N.S.I./N.S.P.I./A.P.S.P. RECOMMENDED STANDARDS -"NO DIVING" signage must be permanently attached to the entire perimeter of the pool. See instructions with signage. *IT IS RECOMMENDED TO NOT INSTALL DIVING BOARDS AND/OR SLIDING EQUIPMENT ON RESIDENTIAL POOLS*. Then add the following: If diving boards and/or sliding equipment is installed by the contractor, such diving boards and sliding equipment MUST BE INSTALLED WITHIN THE GUIDELINES ESTABLISHED BY ANSI/NSPI/ASPA RECOMMENDED STANDARDS, AND IN ACCORDANCE WITH ALL APPLICABLE STATE AND LOCAL CODES AND REGULATIONS.

